



RACE CHIP



RaceChip *Ultimate* **Installation Guide**

Common Rail 2-Channel



Contents

- Foreword** **4**
- Scope of delivery** **5**
- Installation** **6**
 - First steps for installing the RaceChip 6
 - Removing the engine cover 8
 - Connecting to sensors 9
 - Connecting the RaceChip to a wiring harness 16
 - Fastening the RaceChip 17
 - Completing the installation 19
- Troubleshooting** **20**
- Fine-tuning the RaceChip** **22**
- Index of plugs** **25**
- Contact us** **28**

Foreword

Dear customer,

Finally - you are now the proud owner of a new RaceChip Ultimate! In just a few minutes you will experience the tremendous driving pleasure that RaceChip offers.

Regardless of whether you are on bending country roads, accelerating away at traffic lights or coasting on motorways, your RaceChip is guaranteed to thrill! The "RaceChip Effect" allows a completely new dimension of driving pleasure, as your vehicle gives you performance the like of which you have never experienced before. And you are not alone! Every year we welcome over 100,000 new RaceChip enthusiasts across the world. Our top priority is to offer you the best performance enhancements for your vehicle – with the best technology and quality standards.

Your feedback helps us to become even better. We would be thrilled to hear about your new driving experiences with RaceChip.

So start looking forward to your first drive with your new RaceChip. After installing you can begin straight away.

Happy driving.

Your RaceChip Team





Scope of delivery



RaceChip Ultimate

individually customised for your vehicle.



Wiring harness

Automobile-grade, suitable for your vehicle.⁽¹⁾

Other equipment

- **Deactivation plug**
for resetting your vehicle to its factory settings.
- **Cable tie**
for fastening the RaceChip and wiring harness in your engine bay.
- **Torx key**
in case you wish to open the RaceChip
- **Installation guide**
for installing your new RaceChip in just a handful of steps.
If they are available, we will send you additional vehicle images for the installation process via e-mail.

⁽¹⁾ Picture may differ from delivered product.

Installation

First steps for installing the RaceChip



Before installing the RaceChip, please first wait for your engine to cool down. Otherwise there is a risk of sustaining burns.



Open your vehicle's bonnet and close and lock the doors. For vehicles with a **keyless system**: please place the key outside the radio reception range of the vehicle (to be on the safe side, at a distance of 10 metres).



After locking the vehicle, wait another 10 minutes. This ensures that there is no residual electrical voltage in the engine bay connections and that the signal flow in the engine ceases.



Generally speaking, you do not require special tools to perform the installation. However, a simple wire cutter is useful for the purposes of removing excess material from the cable tie once the installation is complete.



In the following section we explain how to install your RaceChip using an example engine. If your engine has a different design, individual engine parts may be arranged differently in the engine compartment when compared to the images here. However, the parts that are relevant for the Race Chip are largely the same.

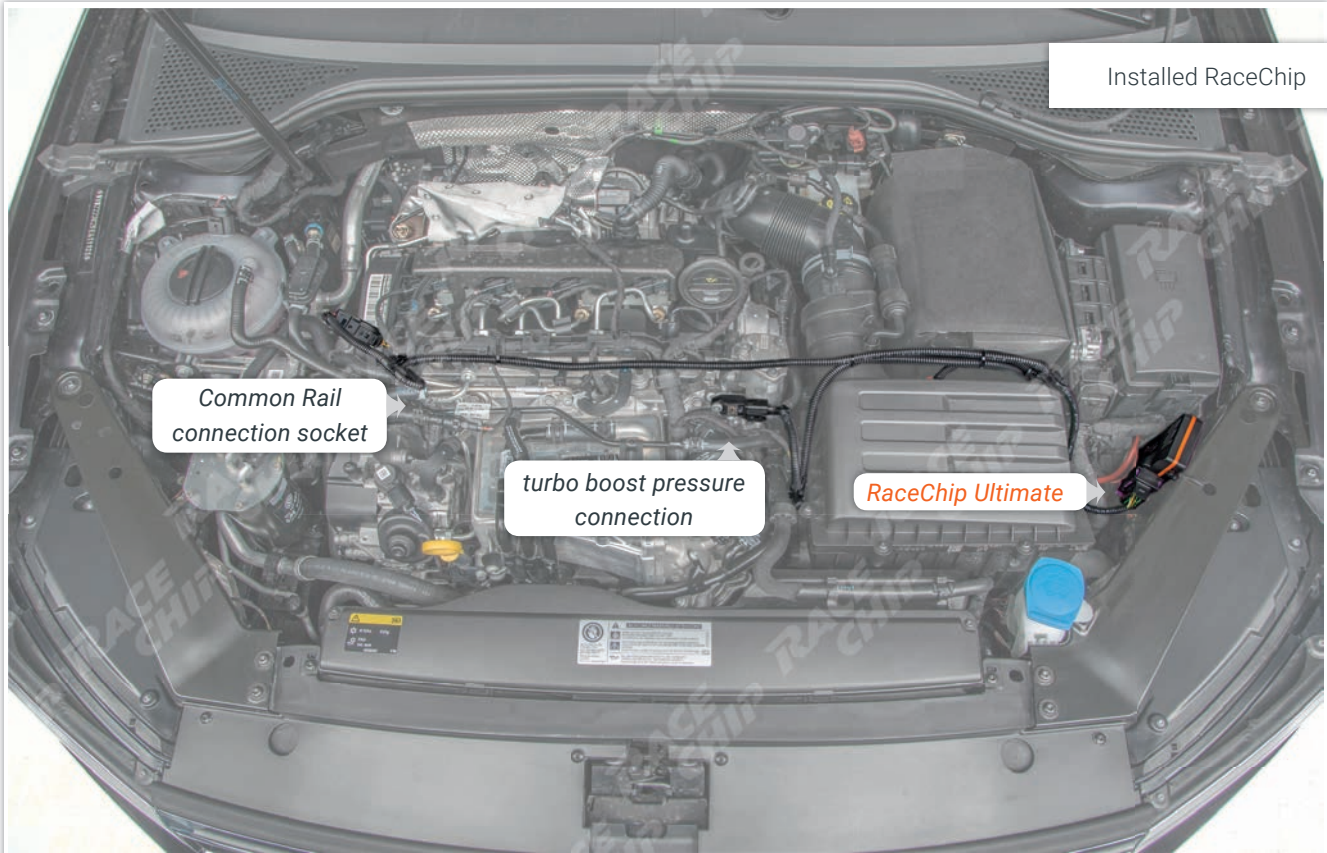

This is how the RaceChip looks in its final installed position. We will now explain step-by-step how to install it.

Setup illustration

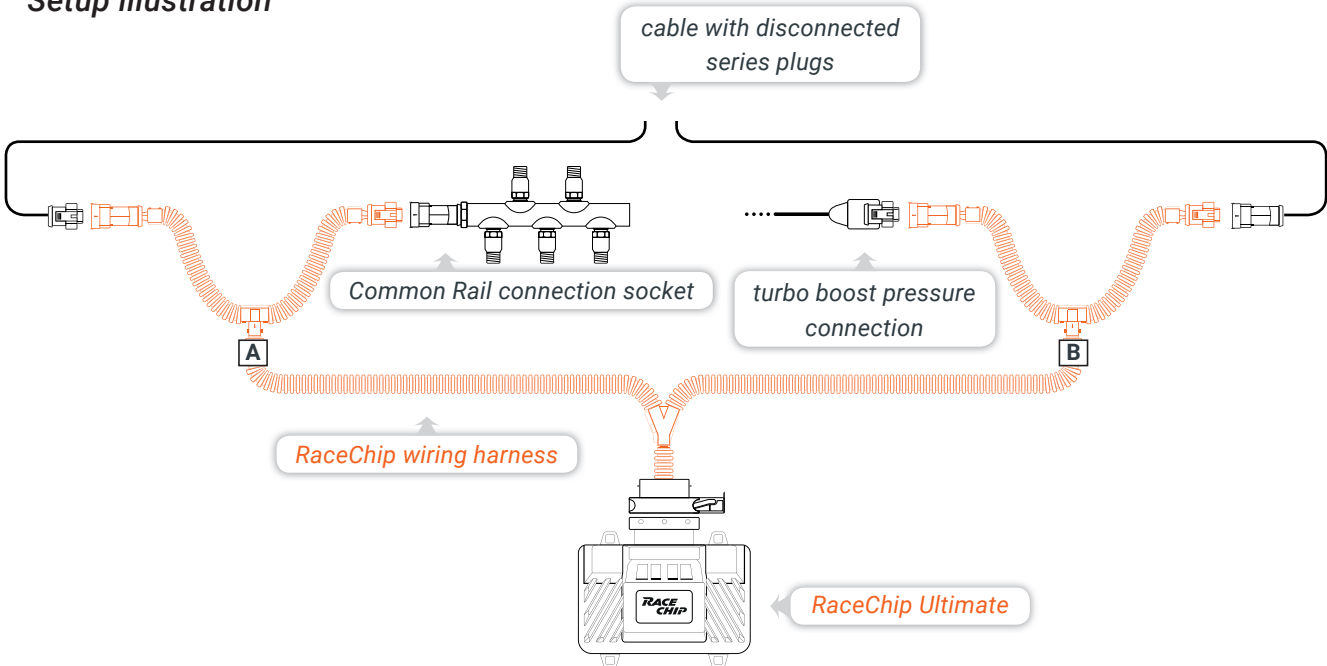

Removing the engine cover



Remove the engine cover from the holding clips and place it next to the car. You must jiggle the cover slightly to release it from the holding clips. If there is no cover on your engine, you can proceed directly to step 2.



Removing a bolted engine cover

In some vehicles it is necessary to loosen one or more bolts before you can remove the engine cover.



Connecting to sensors

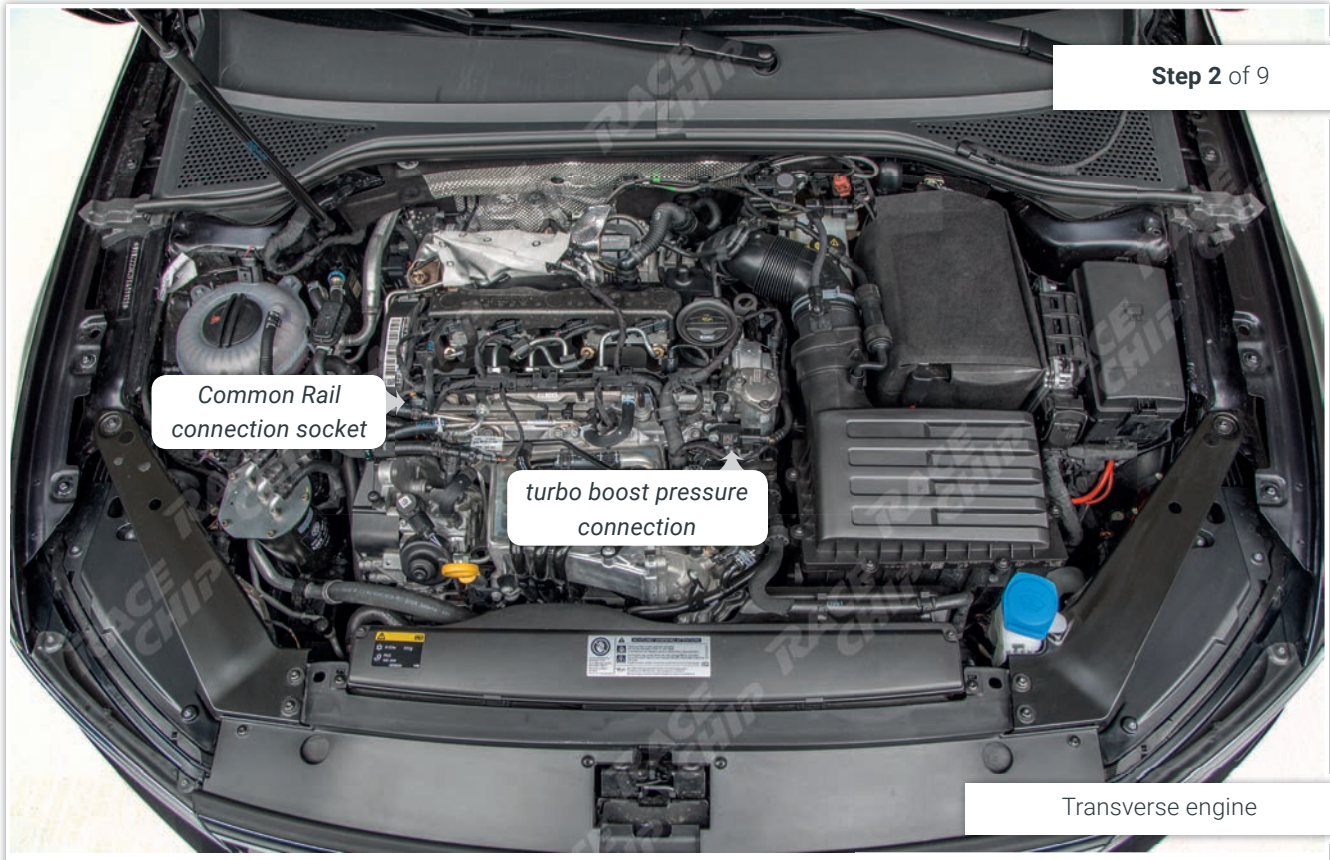

This image shows the connections that is relevant for the installation in your vehicle.



It may be the case that the engine in your vehicle is not longitudinal, as shown in step 2, but rather transverse. In this case you must apply the steps of the installation instructions to the type of engine you have. The installation steps remain the same.

Please check your e-mail inbox. If available, we will send you additional vehicle images for the installation via email.

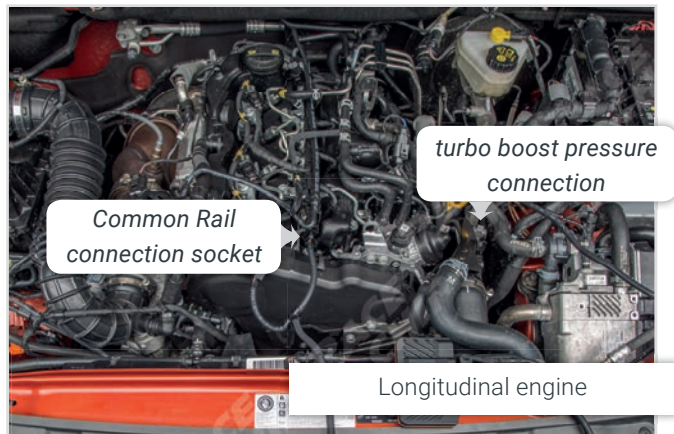

Step 3 of 12

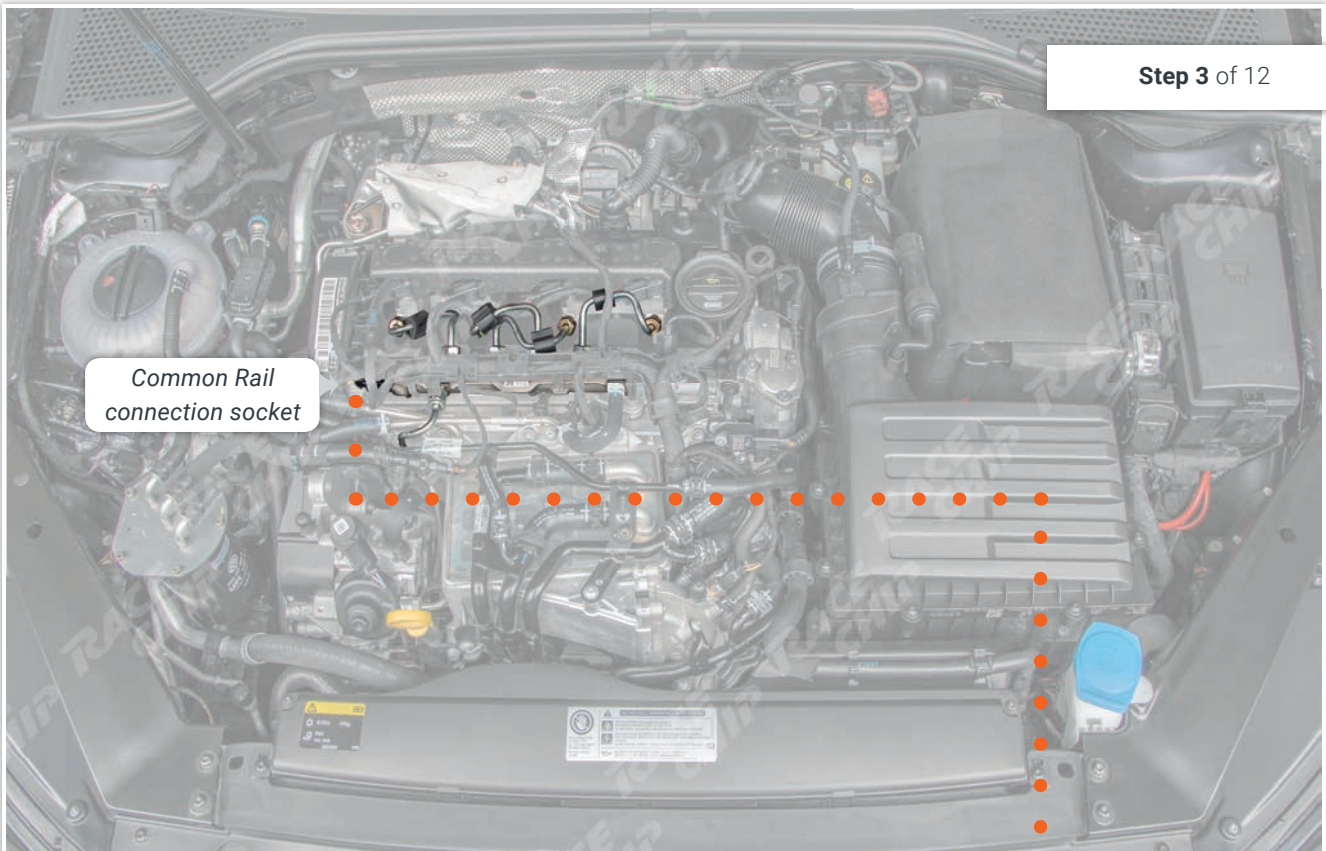

First locate the Common Rail connection socket in your engine bay. The connection socket to the Common Rail is located either at one of the ends or centrally on the Common Rail and can be clearly identified by the large union nut. The best way to find the rail itself is by following the injection lines. These always lead directly into the injection system, i.e., they can be traced back from the engine block.

Setup illustration

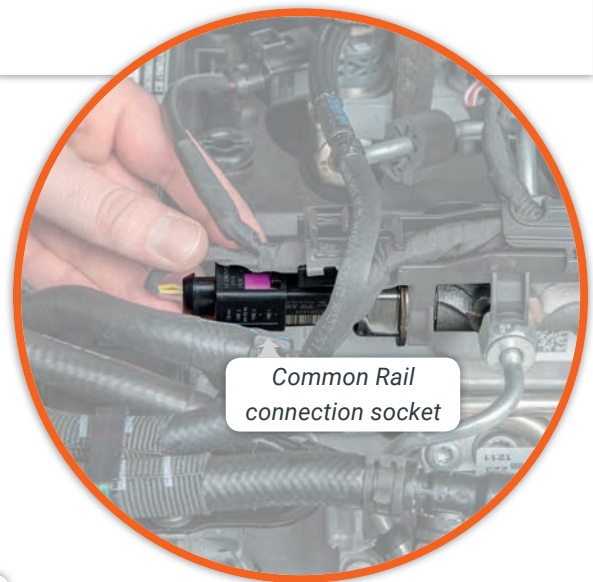
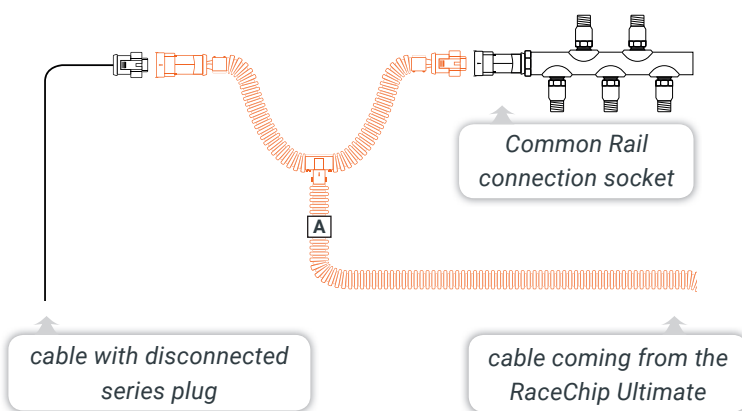

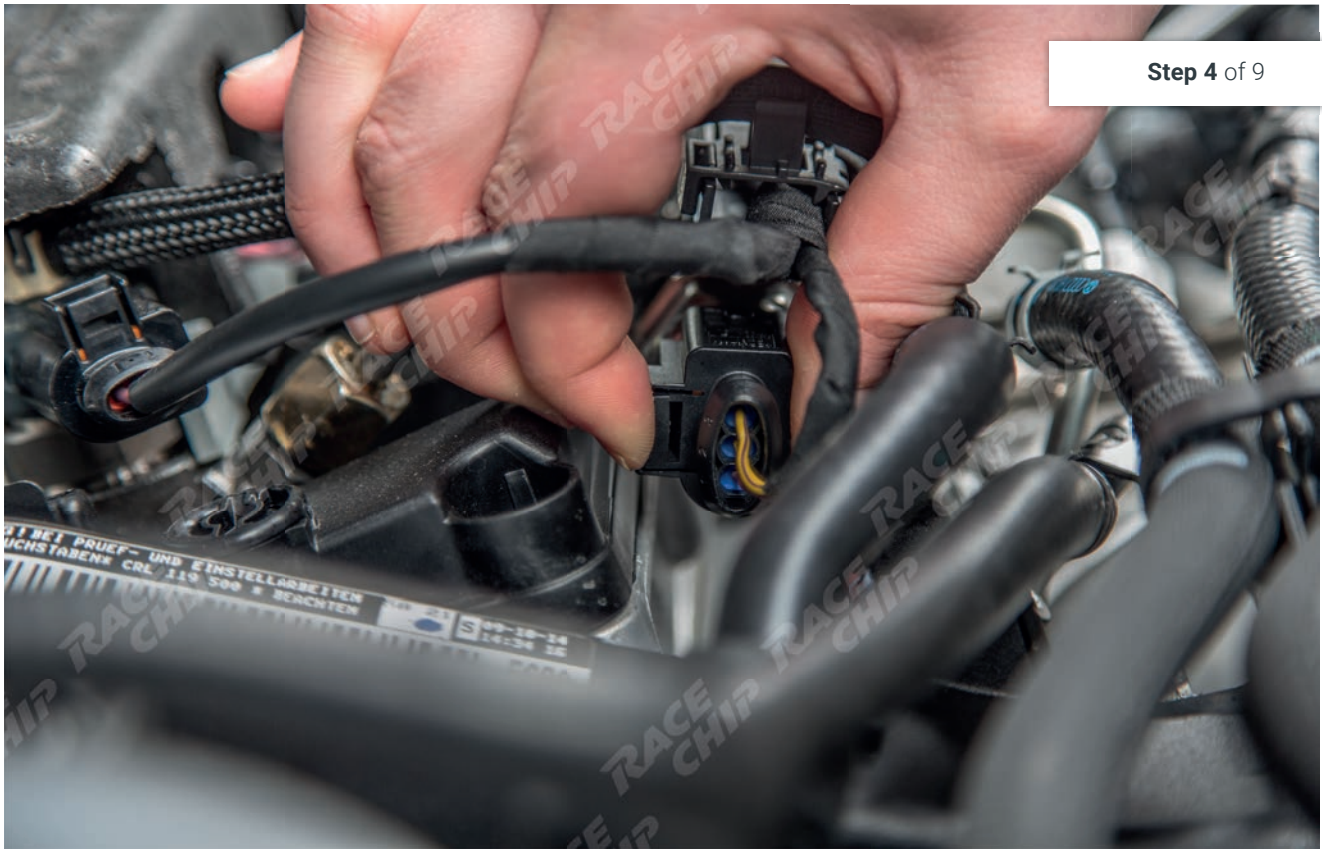

Step 4 of 9

Now remove the plug from the connection socket by gently pressing the locking plug (see image below).

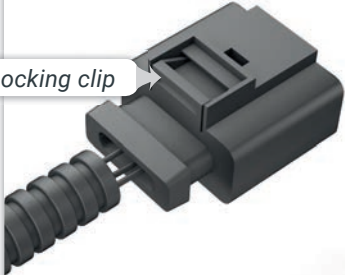

Locking clip

The plugs are locked into the connection sockets by means of a *locking clip*. Press the *locking clip* and pull the plug.

Because the plug is often connected very tightly to the socket, it is helpful, when pressing the *locking clip*, to first push the plug towards the connection socket before subsequently pulling on it.

In addition, temperature fluctuations in the engine bay can result in a type of "vacuum effect" between the plug and the socket. This can be solved by lightly "wiggling" the plug.

Please note that there may be different versions of the installed connection plug. If the plug shown here does not correspond to the plug in your car, you will find a list of other plugs on page 25 with tips on how they can be removed.

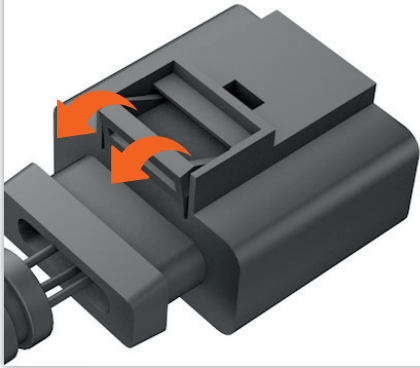

Step 5 of 12

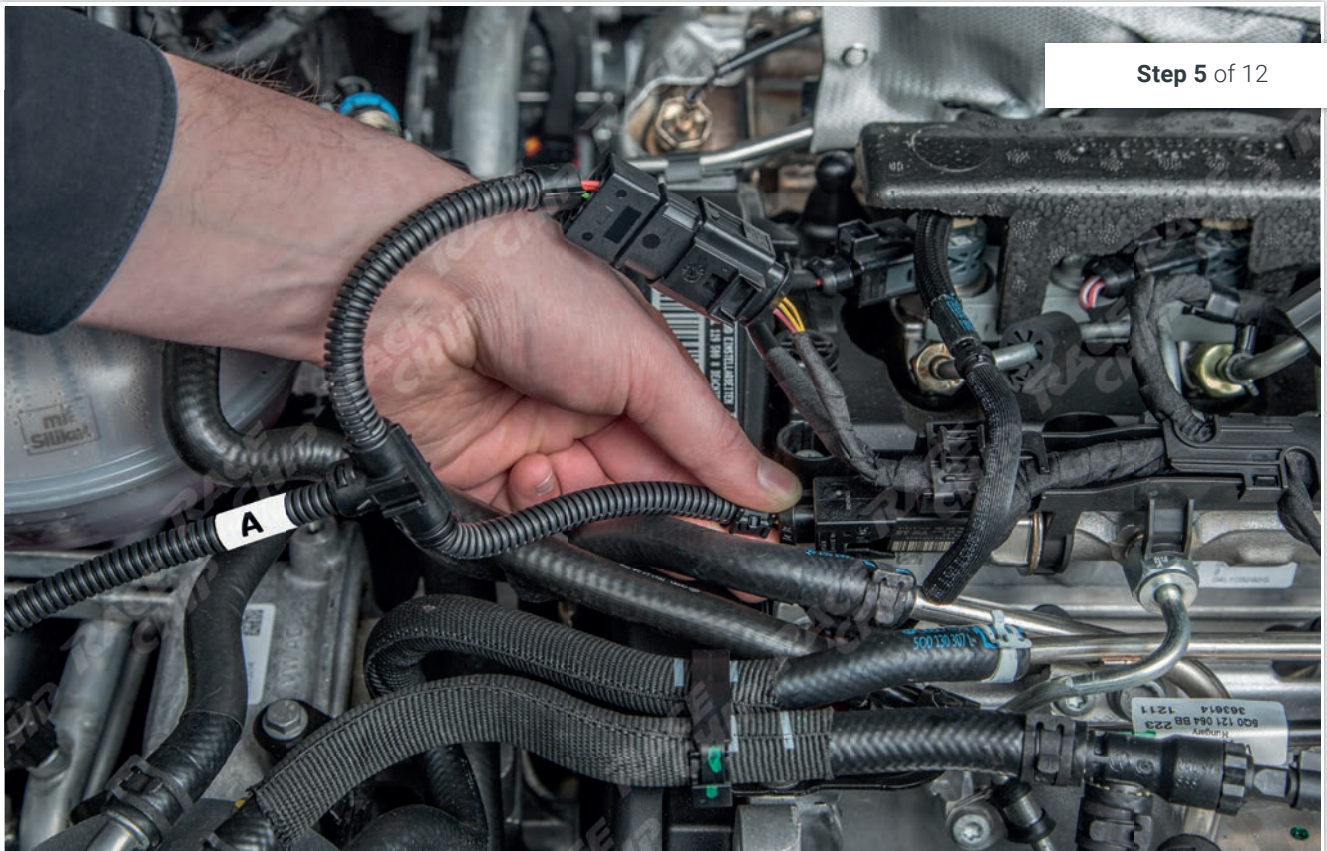

Now connect the part of the RaceChip wiring harness marked "A" to both the disconnected series plug and the socket in your vehicle. Make sure that the plug's locking clip engages again.



Step 6 of 12

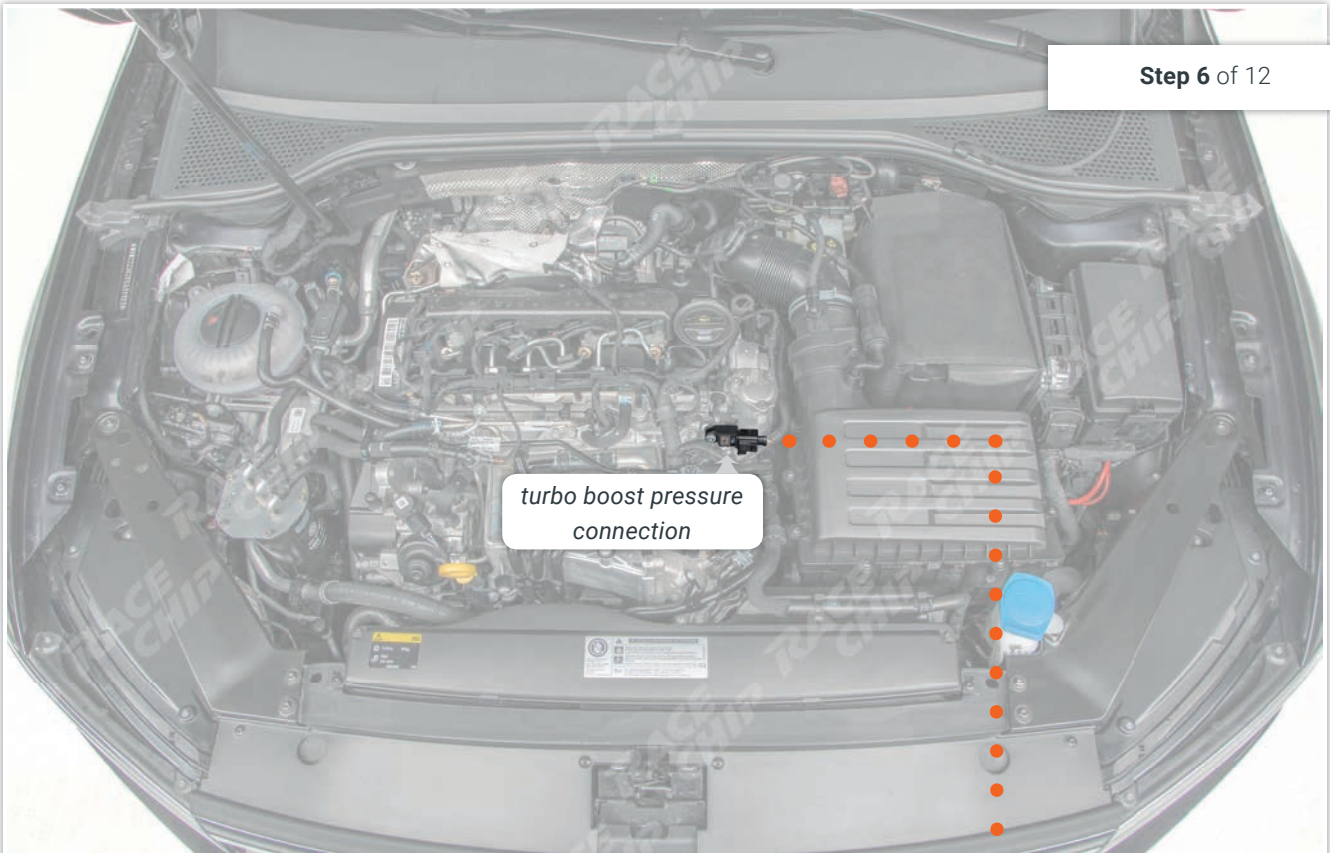

Once the connection to the Common Rail is complete, it is time to make the connection to the turbo boost pressure. To begin, locate the turbo boost pressure in your engine bay (see image below).

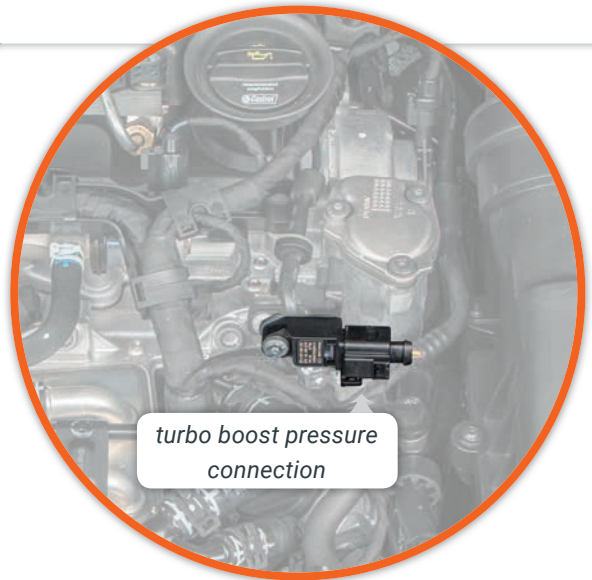

Setup illustration

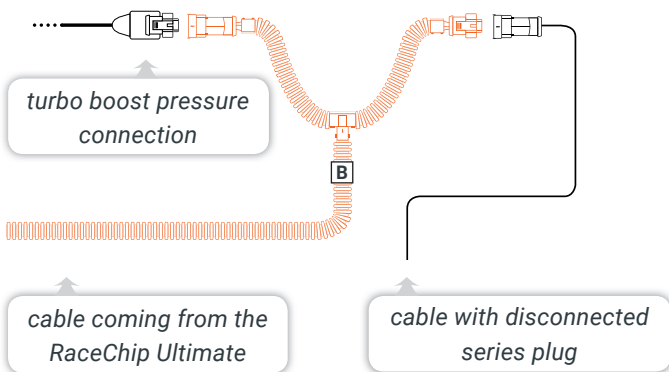

Step 7 of 12

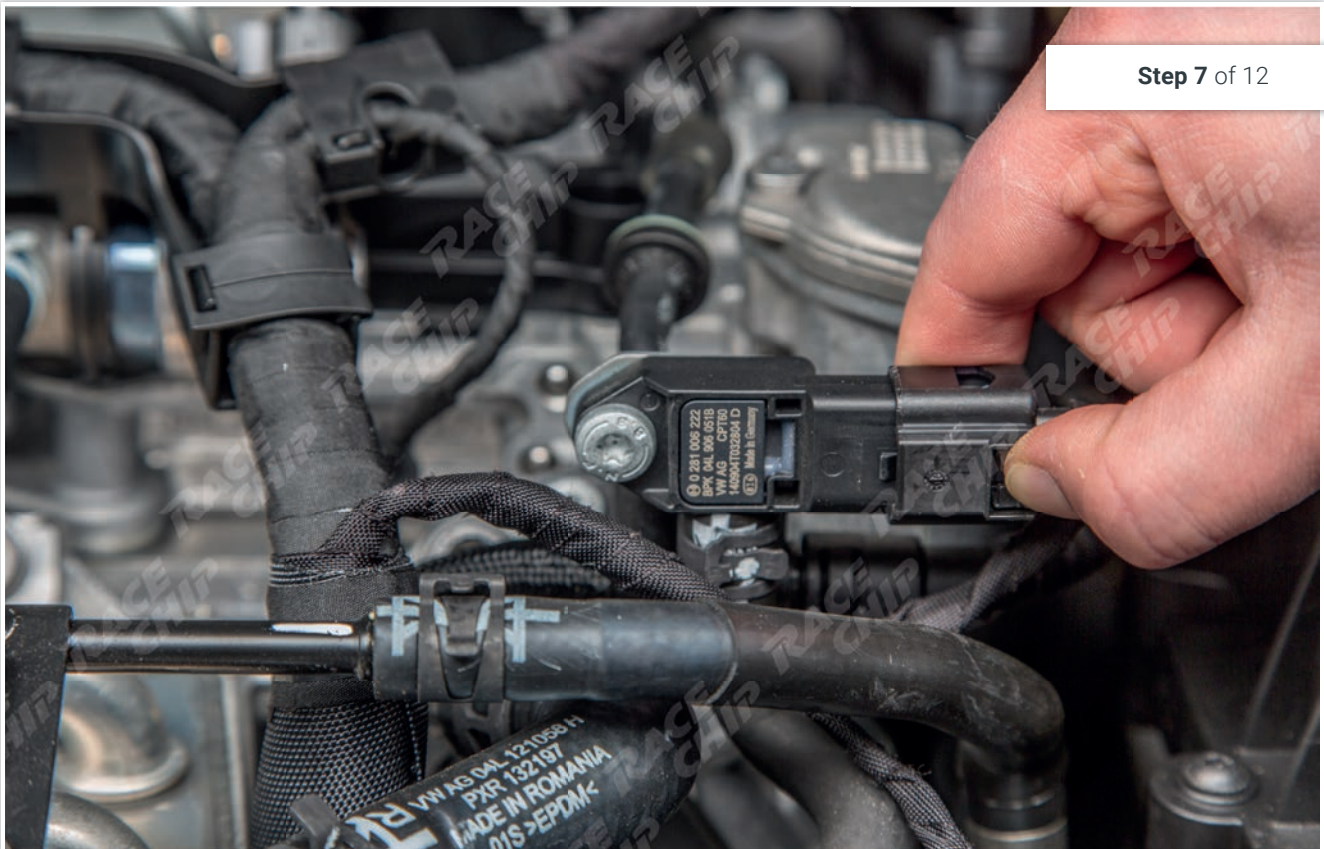

Now remove the plug from the connection socket by gently pressing the locking plug (see image below) while removing the plug from the socket.

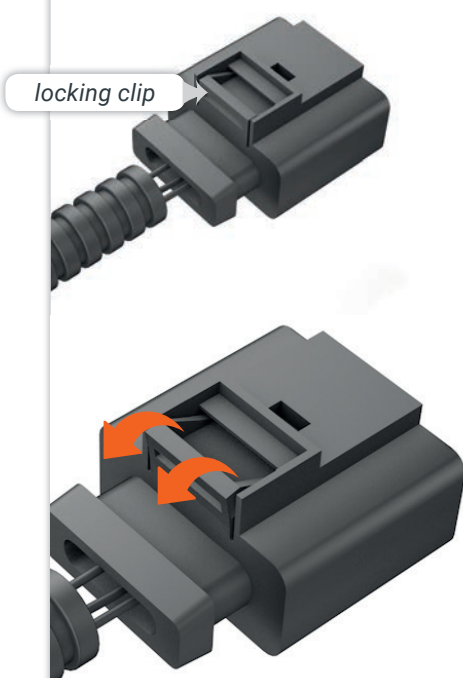

The plugs are locked into the connection sockets by means of a *locking clip*. Press the *locking clip* and pull the plug.

Because the plug is often connected very tightly to the socket, it is helpful, when pressing the *locking clip*, to first push the plug towards the connection socket before subsequently pulling on it.

In addition, temperature fluctuations in the engine bay can result in a type of "vacuum effect" between the plug and the socket. This can be solved by lightly "wiggling" the plug.

Please note that there may be different versions of the installed connection plug. If the plug shown here does not correspond to the plug in your car, you will find a list of other plugs on page 25 with tips on how they can be removed.

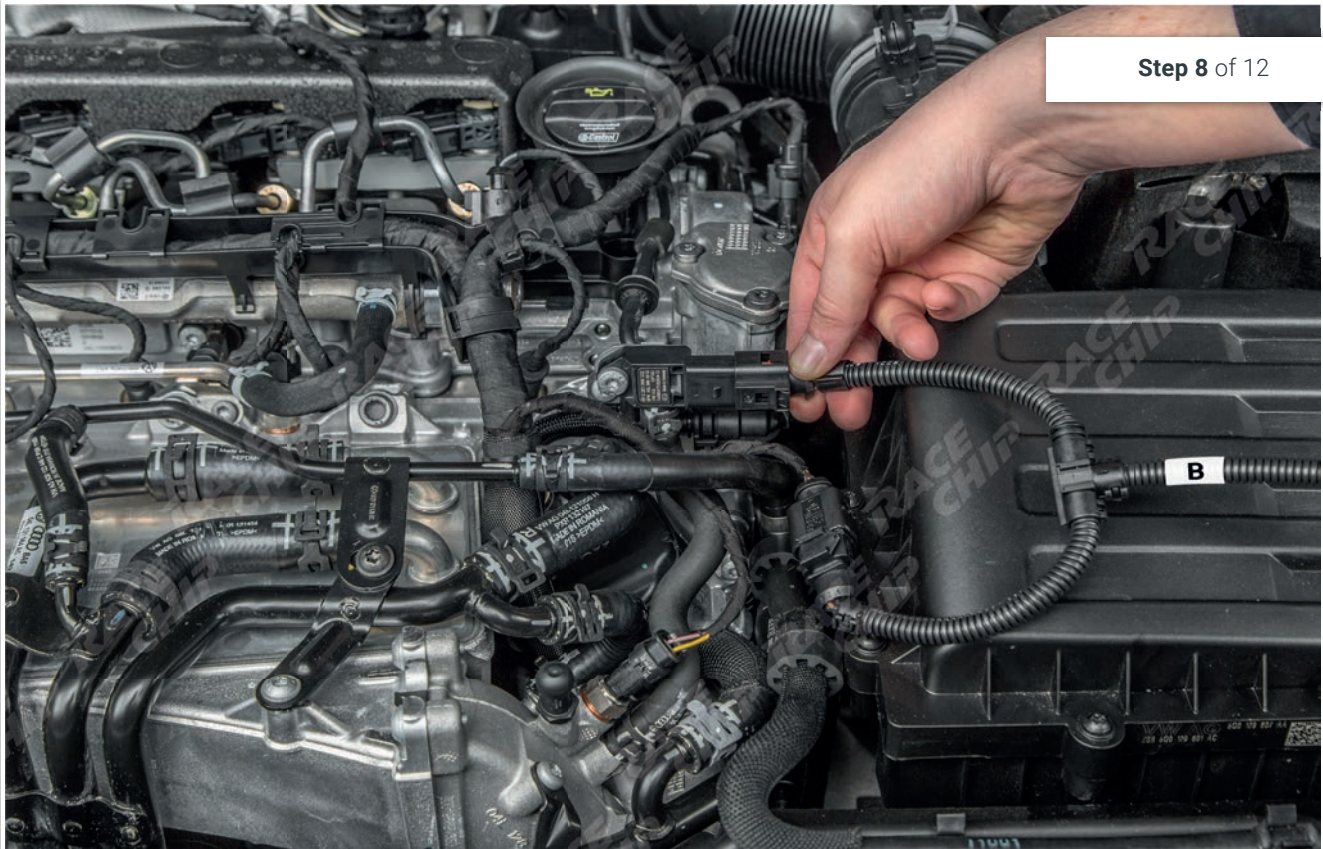

Now connect the part of the RaceChip wiring harness marked "**B**" to both the disconnected series plug and the socket in your vehicle. Make sure that the plug's locking clip engages again.

Connecting the RaceChip to a wiring harness



Wiring harness with deactivation plug removed



Wiring harness with RaceChip connected

Now connect your RaceChip to the newly installed wiring harness. To do so, first remove the deactivation plug that is still connected to the RaceChip wiring harness in its as-delivered condition. Pull the purple-coloured plug outwards and then remove the deactivation plug from the wiring harness connector.



Deactivation plug

The deactivation plug allows the vehicle to be restored to its factory settings without the need to remove the RaceChip wiring harness. In order to use the deactivation plug, you must remove the RaceChip from the wiring harness connector and then replace the chip with the deactivation plug.

If you wish to replace the RaceChip with the deactivation plug at some stage in the future, please ensure that there is no electrical voltage present (see notes on page 6).



Fastening the RaceChip

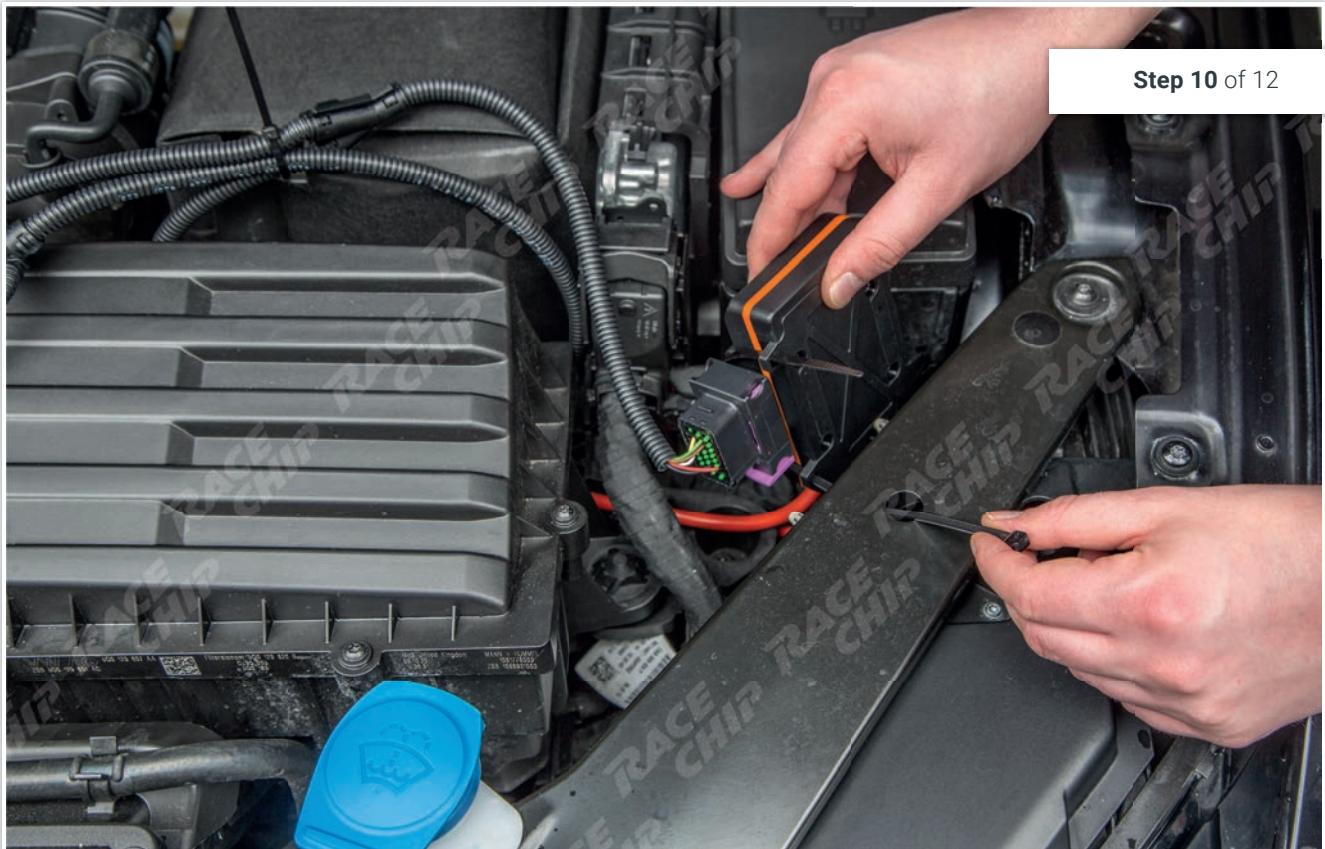

When searching for a secure fastening point for the RaceChip, make sure that the wiring harness can be properly routed in the engine bay in the next installation step. The harness must not, for instance, be routed along engine parts that become very hot, nor should the harness be routed under tension. Fasten the RaceChip in place using the supplied cable tie, as illustrated in the image above.



- When selecting a fastening point, make sure that the RaceChip is protected from exposure to water, heat, and vibrations.
- Do **not** wrap the RaceChip in an airtight bag as this can lead to a built up of condensation.

Step 11 of 12



Route the cable along a suitable path (for example, along an existing harness) and then fasten it using the supplied cable tie. Using a wire cutter, you can remove the excess length of the cable tie.



- Do **not** route the cable in areas in your vehicle that become overly hot during operation (e.g. the exhaust system, turbocharger, etc.).
- Do **not** route the cable along movable parts (e.g. fan belts, cam belts, fan wheels).
- Never fasten the cable onto hoses (e.g. a brake hose) as this could result in abrasion.



Completing the installation

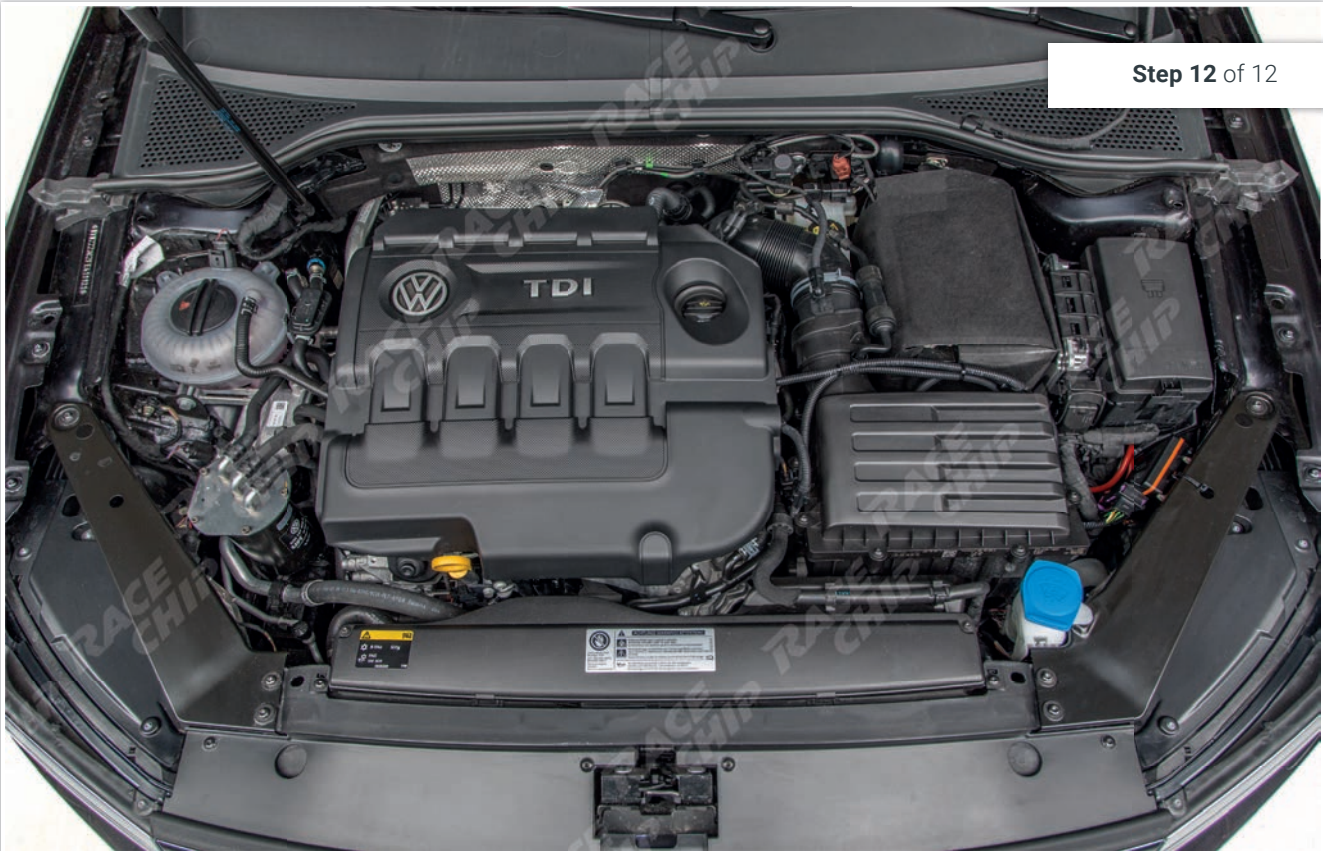

Re-attach the cover of your engine and close the bonnet. The installation process is now complete and your RaceChip is ready for use. Perform a trial run with your vehicle and test the RaceChip with the function you wish to use. Should you have any questions, do not hesitate to contact our Customer Service department (see page 28).

We hope you enjoy using your
RaceChip Ultimate!

Troubleshooting

If, after the installation, your RaceChip does not function as desired, the following list serves as a set of troubleshooting tips.

<p>No performance boost - I am not satisfied with the performance level of my vehicle.</p>	<p>You have the option of individually customising your RaceChip's performance level. It is possible, for example, to increase or decrease the performance boost. To do this, you need to adjust the rotary switch inside the RaceChip. A detailed functional description and the exact location of the switch can be found in the "Fine-tuning the RaceChip" section (starting on page 22). However, it is important to note that our chips are always shipped with what we consider to be the ideal fine-tuned setting for your engine. If, after further fine-tuning, you still do not notice a performance boost, then please contact our Customer Service department.</p>
<p>Rattling - My engine is rattling.</p>	<p>A loud "rattling sound" in a diesel engine does not, in most cases, occur after the installation of the RaceChip. In fact the vehicle runs more smoothly with the RaceChip installed. Ideally you should take a couple of test drives to check whether a rattling sound is still perceptible. If you do hear rattling, then start by following the steps for fine-tuning the RaceChip (beginning on page 22). If this does not solve the problem, please contact our customer service department.</p>
<p>Soot generation - My vehicle gives off sooty smoke.</p>	<p>This problem can arise if the RaceChip's output is too high. But help is at hand: simply adjust the setting of the rotary switch. A detailed description of this procedure can be found in the section on "Fine-tuning the RaceChip" (beginning on page 22).</p>
<p>Jolting - My vehicle jolts after installation of the RaceChip.</p>	<p>It is possible to further customise your RaceChip to the special characteristics of your engine. This involves an additional installation step (see "Fine-tuning", page 22 onwards). If this does not rectify the problem, please provide our Customer Service staff with an exact description of the driving circumstances in which the problem arises. Our colleagues will then suggest further adjustments for solving the issue.</p>



<p>An engine indicator lamp lights up - After installation of the RaceChip, an engine indicator lamp lights up (fail-safe/fault signal)</p>	<p>Firstly, a lit engine indicator lamp does not necessarily mean that something is wrong with your engine. This may be a protective measure designed by the manufacturer. There can be several different causes of an illuminated fault signal once the engine has been started. However, the RaceChip cannot independently bring about this type of fault signal. When the engine is started or at idle speed, the performance boost itself is not active. This type of fault can be the result of a sensor being disconnected while the control unit is active. Please consult the information on page 6.</p> <p>If there is a recurring fault signal, starting and restarting the engine several times may solve the problem. If the engine indicator lamp lights up after a period of driving, please contact our Customer Service staff.</p>
<p>The vehicle does not start - After the installation of the RaceChip, the vehicle's ignition does not work</p>	<p>Please make sure that you have installed the chip in accordance with this guide. If you are not able to establish the error, please contact our Customer Service staff.</p>
<p>No noticeable fuel savings - I do not notice any fuel savings</p>	<p>Please compare the before-and-after levels of fuel consumption based on the vehicle's actual consumption – the on-board computer often displays incorrect values. It is important that you do not inappropriately adjust your driving style as a result of the RaceChip performance boost, i.e. by accelerating more frequently. If the fuel savings provided by the RaceChip in its as-delivered condition are not satisfactory, please contact our Customer Service staff for a fine-tuning adjustment.</p>

Fine-tuning the RaceChip

Your RaceChip is shipped with optimisation software and a chosen factory setting that are customised to your vehicle's engine. In its as-delivered state, the RaceChip guarantees optimum customisation of your vehicle software in line with the RaceChip's own software and also provides the following advantages: **a considerable performance boost within the vehicle's existing reserves, a long engine service life and fuel savings.**

Nevertheless, manufacturer-based production tolerances may have an effect. In order to compensate for these tolerances, there is a rotary switch inside the RaceChip that allows for additional fine-tuning of the RaceChip.

Exemplary factory adjustment:

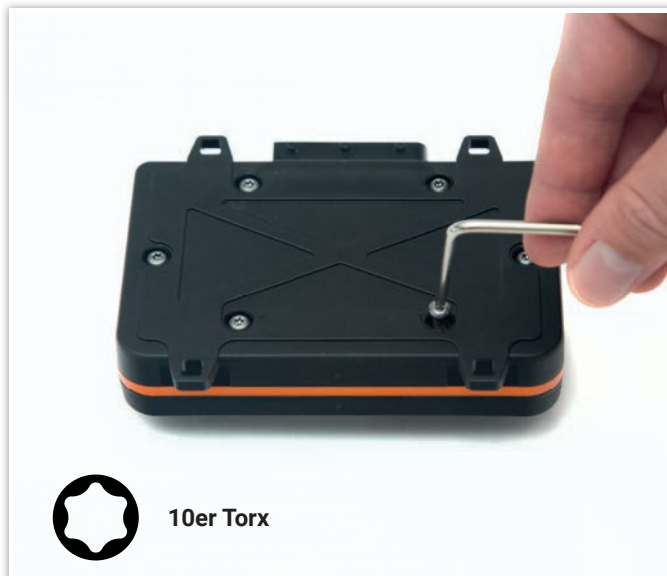
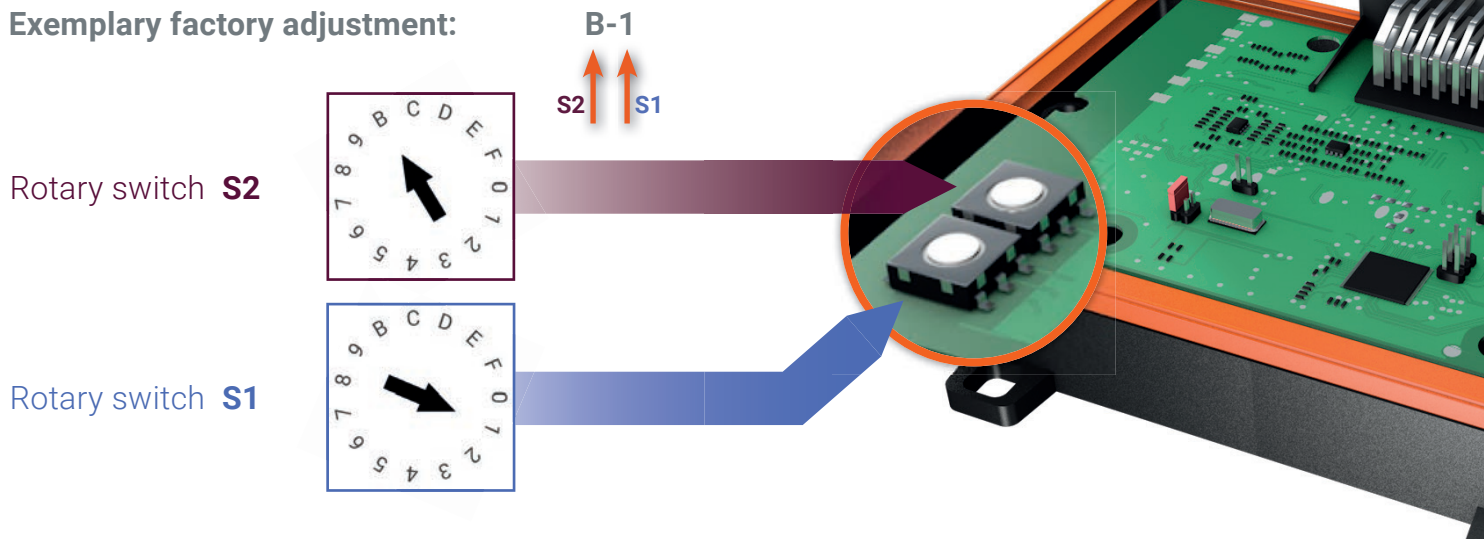

Opening the RaceChip

To open the RaceChip (if necessary), a T10 torx key is included in the scope of delivery (see image). Using this key, unfasten the six screws on the underside of the RaceChip. You can now open the housing.

Example calculation:

- RaceChip Ultimate
Rotary switch position: **B1**
Cable reference: DM-A3001



How do I find the factory setting?

Your bill includes a reference to the factory setting installed in your shipped RaceChip. The factory setting for your vehicle is designated as "B1". The "D" is not significant.



Adjusting the performance boost

If you find that the achieved performance boost does not quite live up to your expectations, it can be tuned further using the rotary switch. Only perform this tuning if the achieved performance boost at the factory setting does not meet your expectations for the engine. Please adjust the performance in incremental steps, starting with Tuning 1. As soon as the desired performance boost has been achieved, stick with this tuning. If your engine begins to jolt while running, then select a lower tuning.

Factory adjustment	Tuning 1	Tuning 2	Tuning 3
S2 S1	S2 S1	S2 S1	S2 S1
9 1	B 1	C 1	D 2
F 1	0 2	0 4	1 4
B 1	D 1	E 2	F 4
C 1	D 1	E 2	F 4
E 0	E 2	F 3	0 4
9 C	C E	D F	D 0
9 B	C E	D F	D 0
B E	D F	E 1	F 1
C E	D F	E 1	F 1
B C	D F	E 1	F 1
C F	D F	E 1	F 1

Improving smoothness of engine operation

If the installation of the RaceChip results in jolting, tapping or banging noises, or if an engine indicator lamp lights up, smooth operation of the engine can be restored by using a suitable fine-tuning adjustment. Please proceed in incremental steps, as illustrated below. First, set the rotary switch to Tuning 1 and start your vehicle's engine. If your engine is running as smoothly as you would like and no engine lamps light up, then begin increasing the setting with the rotary switch, starting with Tuning 2. Perform a test drive each time you go up a tuning level. If the engine does not run as desired at a particular tuning level, then go down a level. This level is then the ideal setting for obtaining a performance boost based on the special characteristics of your engine.

If your engine does not run as you would like in any tuning setting, or if an engine indicator lamp lights up in service mode, please contact our Customer Service staff.

Factory adjustment	Tuning 1	Tuning 2	Tuning 3	Tuning 4
S2 S1	S2 S1	S2 S1	S2 S1	S2 S1
9 1	8 8	9 9	A C	B E
F 1	9 B	A C	B E	C F
B 1	9 B	A C	B E	C F
C 1	9 B	A C	B E	C F
E 0	9 B	A C	B E	C F
9 C	8 8	9 A	A C	B E
9 B	8 8	9 A	A C	B E
B E	9 B	9 A	A E	B D
C E	9 B	9 A	A E	B E
B C	9 B	9 A	A E	A F
C F	9 B	9 A	A E	B E



Index of plugs

If you have problems identifying your serial plug, you will find a list of all relevant plugs for your vehicle here.

Your plug is not listed? Please contact our Customer Service staff. Our contact information can be found on page 28.

Plug variant I

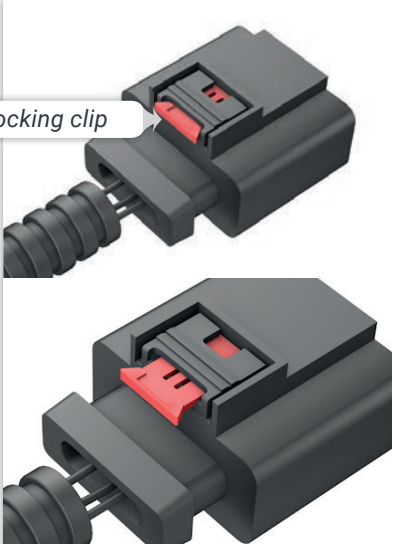

In the first step, the red *locking clip* is pulled out. Press the red *locking clip*, which functions as a lever for loosening the plug and pulling it out.

Because the plug is often connected very tightly to the socket, it is helpful, when pressing the *locking clip*, to first push the plug towards the connection socket before subsequently pulling on it.

In addition, temperature fluctuations in the engine bay can result in a type of “vacuum effect” between the plug and the socket. This can be solved by lightly “wiggling” the plug.

Plug variant II

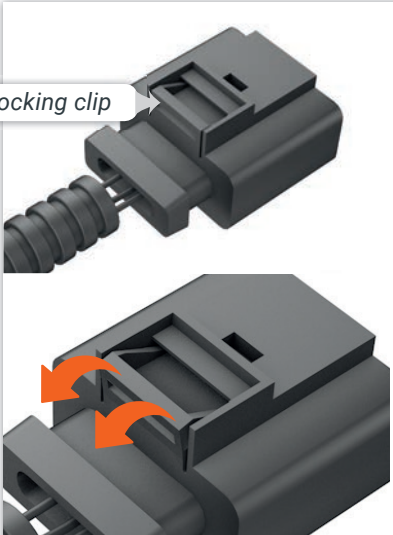

The plugs are locked to the connection sockets by means of a *locking clip*. Press the *locking clip* and pull the plug.

Because the plug is often connected very tightly to the socket, it is helpful, when pressing the *locking clip*, to first push the plug towards the connection socket before subsequently pulling on it.

In addition, temperature fluctuations in the engine bay can result in a type of “vacuum effect” between the plug and the socket. This can be solved by lightly “wiggling” the plug.

Contact us

We are always here to help!



Normal landline and mobile phone charges apply.

Contact us at:

+49 (0) 7023 - 77 999 - 0

Our service hotline is available from:

Monday to Friday, from 8:30am to 12:30pm
and from 2:30pm to 5:30pm.

Please have your customer details ready when you call. This allows us to access your key data quickly, and to help you as fast as possible.

You can also get in touch using our contact form:

www.racechip.de/kontakt

Imprint

RaceChip Chiptuning GmbH & Co. KG

Ulmer Straße 123
73037 Göppingen
Germany

Umsatzsteuer (VAT) Identification number: DE 260672432

Registered at the District Court of Ulm: HRA 721734 Tax number: 63079/11153

Personally liable partner: RaceChip Chiptuning Verwaltungs GmbH Chief Executives:

Manuel Götz, Dominic Ruopp, Dr. Daniel Appelhoff, Dirk Bongardt

Head office: Ulmer Straße 123, 73037 Göppingen, Germany

Registered at HRB District Court, Ulm: HRB 724254